

vision
without
limits

CANTY
PROCESS TECHNOLOGY

CANTY LIGHTS Process Lighting



OPTIMUM VIEWING

CANTY HYL lighting systems are designed to illuminate for optimal viewing. Our patented design transmits an intense beam of light into a process or pressure vessel. Conical light beam options of 30° (normal beam) or 90° (wide beam) are available.

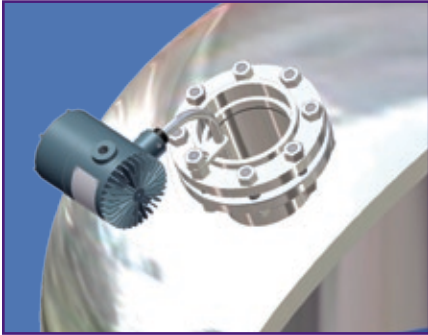

CANTY 12" bundle models mount directly to a sight glass with an optional bracket.

- View and illuminate through one nozzle
- Maximum illumination
- Cool light output - eliminates product bake-on
- 50W & 80W models

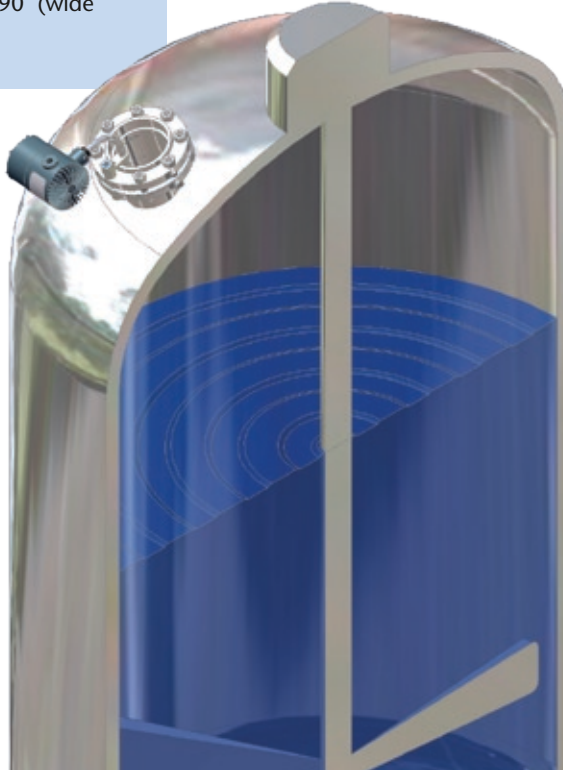

FIBER OPTIC BUNDLE LIGHTING

CANTY provides a combined light and sight glass to optimize viewing and minimize total package cost. Illuminate through an existing sight glass or a newly installed FuseVIEW™.

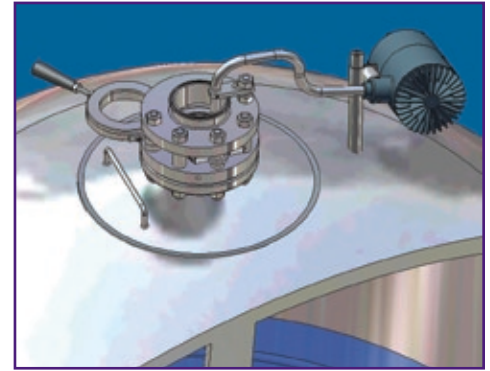

CANTY 24" and longer bundle models mount remotely from the sight glass with an optional bracket for increased accessibility. Illustration above includes optional CANTY QUICKFILLVIEW PORT™.

- High Intensity Lighting
- NEMA 4, IP66, Explosion proof, Flame proof models
- Fused glass seal provides a safe, reliable, hermetic seal between electronics and the process area.



FLANGE, NPT, TRI-CLAMP®, NA-CONNECT®

No Sight Glass Required, Direct Mount To Tank Connection



- 316L SS, Hastelloy® C276, Hastelloy® C-22®, glass wetted material options
- ANSI and DIN mounting options
- Pressure ratings to 10,000 PSI [690 bar] available

MOUNTING OPTIONS

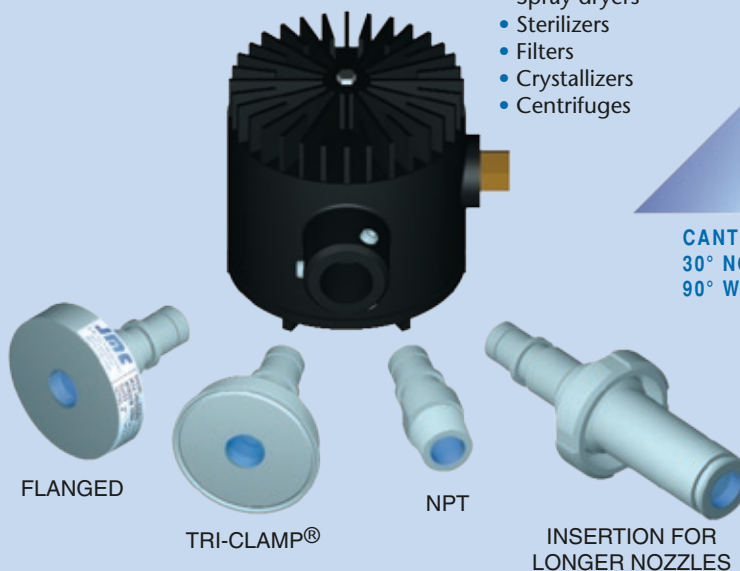

APPLICATIONS

- Process vessels
- Solid material hoppers
- Spray dryers
- Sterilizers
- Filters
- Crystallizers
- Centrifuges

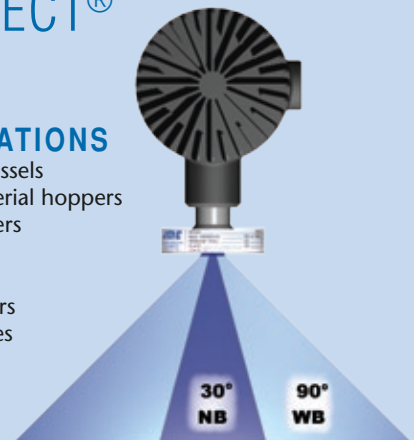

CANTY LIGHT BEAM OPTIONS:
30° NORMAL BEAM
90° WIDE BEAM

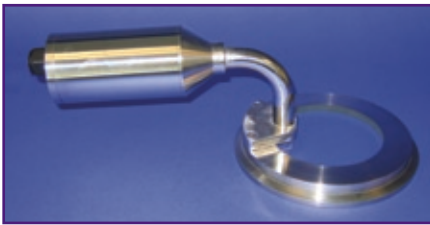

PUREVIEW™ Sanitary Light and Sight Glass

The CANTY PUREVIEW™ is a sanitary / hygienic fiber optic light and fused sight glass combination. The PUREVIEW™ combines the maximum viewing area through a CANTY FUSEVIEW™ sanitary sight glass with a high output sanitary Canty light, providing the best view possible while minimizing space needed and number of connections.

The TriPORT™ Hinged Sanitary Light and Sight Glass System combines the PUREVIEW™ with a unique hinged connection which allows the user to easily and quickly unclamp and pivot the sight glass and light combination away from the ferrule in just seconds. The TriPORT™ system remains supported by the ferrule and can quickly pivot back into place.

SANITARY LIGHTING

APPLICATIONS

- Biotech Applications
- Fermentors
- Food Applications
- Sterile Process Applications
- Sanitary Areas

FEATURES

- Meets ASME / BPE Standards
- 316L and Hastelloy® Materials
- NEMA 4X / IP66
- Cold Light
- Fused Glass - Safe Light
- CIP/SIP Process Compatible



HYL 52 Lighting System



The CANTY HYL 52 and HYL 82 series lighting systems are sanitary / hygienic lights used in the BioTech industry. They provide a high intensity, true white light for optimal illumination while adding no heat to the process.

All CANTY lights feature a hermetic, fused glass, high pressure / temperature seal to completely seal the light from the process. The 316L design and variety of mounting connections make CANTY lights ideal for any application.

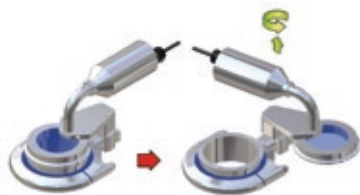

HOW IT WORKS!



TriPORT™ Hinged Sanitary Light and Sight Glass System



ULTRAPURE™ Insertion Sanitary Light



30° NORMAL BEAM

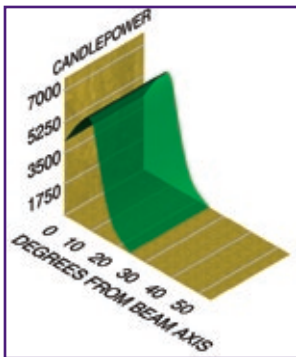

90° WIDE BEAM

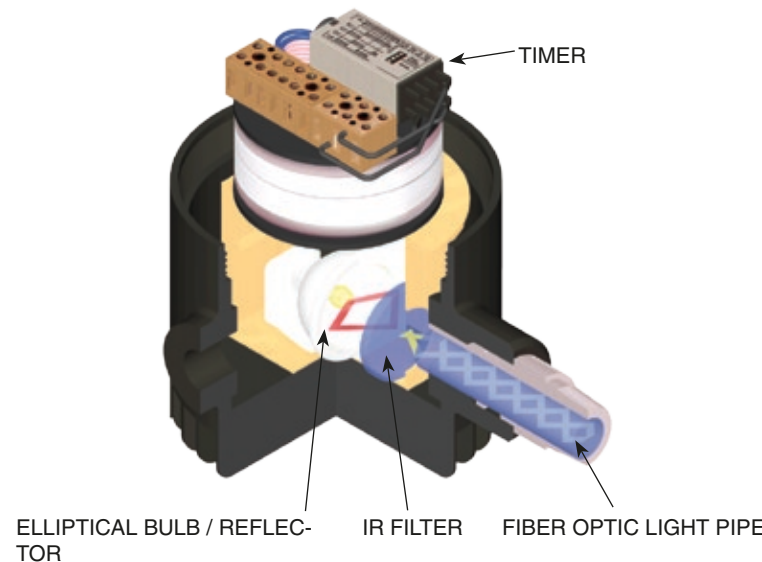
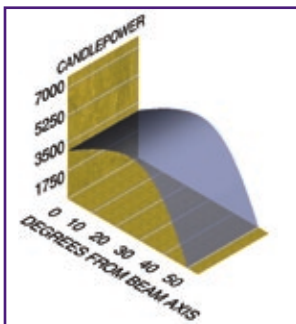

Canty lights feature a high output halogen bulb and reflector assembly that focuses the light from the bulb into the process vessel or tank. An infra-red filter is used to remove all heat from the light, providing only cool light into the process and eliminating sight glass bake-on. Conical light output of 30° (normal beam) or 90° (wide beam) are available.

1 HOUR BAKE-ON TEST

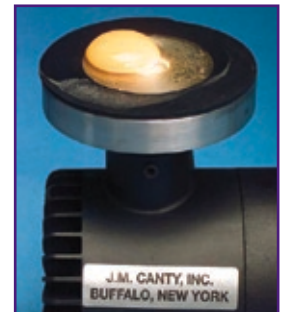

CANTY COLD LIGHT



COMPETITOR'S LIGHT
NOTE: EGG IS BAKED ON

Industrial Sight Glasses and Sight Flows

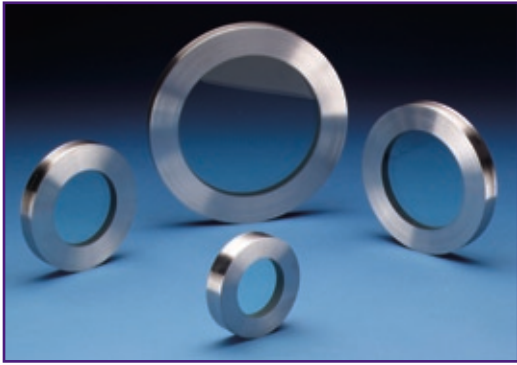

THE ENGINEERED ADVANTAGE

CANTY FUSEVIEW™ sight glasses have been engineered to meet all of your process and safety needs. All standard FUSEVIEW™ feature Factory Mutual approval and are designed and tested to ensure the safest product available. CANTY can provide certification of material and testing if required, following ASME code and TUV requirements for process vessels.

Our unique fused glass windows far exceed all conventional tempered glass windows in safety and performance. CANTY windows can be easily removed for cleaning and do not have to be discarded as do traditional tempered sight glass windows.

FUSEVIEW™ ANSI / DIN

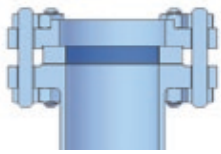

CANTY FUSEVIEW™ flanged sight glasses are ideal for new or retrofit applications and are available in ANSI and DIN as well as almost any custom size. FUSEVIEW™ models feature the largest viewing area of any fused sight glass on the market today.

GLASS WETTED FUSEVIEW™

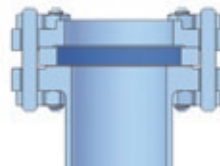

Glass wetted FUSEVIEW™ sight glasses are designed for glass-lined reactors where only glass is allowed in contact with the product. The large diameter fused glass seal allows the gasket to seal on glass only, not the metal. Perfect for glass wetted, C2000 and exotic material reactors.

FUSEVIEW™ HIGH TEMP

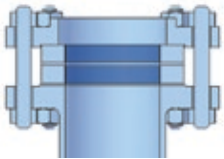

CANTY FUSEVIEW™ High Temp sight glasses include dual FUSEVIEW™ sight glasses for extreme high temperature applications. The dual sight glass package insulates the inner FUSEVIEW™ sight glass against extreme thermal shock.

QUARTZ / SAPPHIRE SHIELD FOR FUSEVIEW™

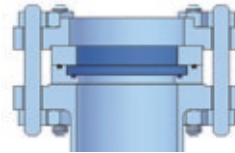

CANTY quartz or sapphire shields can be added to any FUSEVIEW™ ANSI / DIN sight glass for caustic service. Replaceable molecular quartz or sapphire shields are available when required due to process conditions.

CANTY SIGHT FLOWS

All CANTY sight flows come standard with FUSEVIEW™ sight glasses to provide the safest sight flow in the industry. Our sight flows have been designed to meet strict ASME code requirements and all units are hydro-tested to 150% of the maximum rated pressure.



F700 Series Flanged Connection

MODELS

- Flanged
- Threaded
- Welded
- Tri-Clamp®
- Teflon® Lined

FUSED GLASS ADVANTAGE

All CANTY sight flows feature FUSEVIEW™ sight glasses to ensure safety. By fusing glass to metal, a high pressure, high safety and high impact hermetic seal is formed.



S100 Series Threaded Connection



COATED VIEW



JET SPRAY RING ACTION



CLEAR VIEW

CANTY Jet Spray Rings generate a high pressure vortex rinsing action to remove tough deposits from sight glasses, lights, and vision systems. The Jet Spray Ring may be used for constant or instantaneous cleaning.

JET SPRAY RINGS

JET SPRAY RING - U.S. SPACE PROGRAM ORIGIN

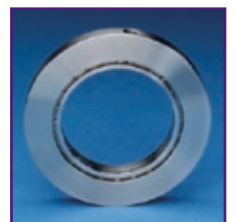
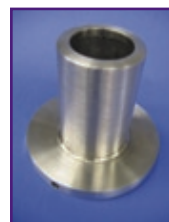

CANTY FUSEVIEW™    PED ASME BPE

Sanitary Sight Glasses and Sight Flows

CANTY Sanitary FuseVIEW™ sight glasses are fused, one-piece sight glasses, featuring a hermetic fused glass to metal seal. The CANTY high pressure, fused glass design requires no special gasketing or torque requirement. CANTY Sanitary sight glasses have been designed and tested to ensure the safest product available.

CANTY can provide certification of material and testing if required, following ASME code and TUV requirements for process vessels.

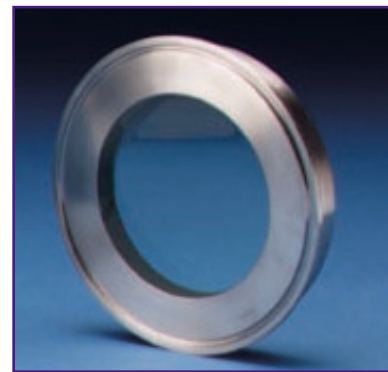

TRI-CLAMP® FUSEVIEW™



Tri-Clamp® FuseVIEW™ sight glasses are available in full view and flush mount styles. The hermetic, sanitary design is ideal for sanitary applications. CANTY features the largest viewing area of any fused sight glass on the market today.

AESEPTIC NA-CONNECT® FUSEVIEW™



Aseptic NA-Connect® FuseVIEW™ sight glasses are designed for sanitary, CIP/SIP applications. The sanitary design eliminates air pockets and trapped material and is designed for full torquing. They cannot be over-torqued.

SANITARY FLANGE FUSEVIEW™

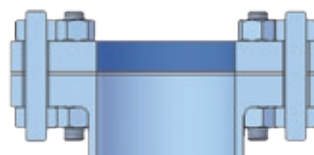

Sanitary Flange FuseVIEW™ sight glasses incorporate a thru hole bolt pattern in the sight glass, eliminating the need for a retaining flange. The low profile design and hermetic, fused seal provide a high strength, sanitary sight glass free of air pockets or pockets for material accumulation.

CANTY SANITARY SIGHT FLOWS



Sanitary Connection

CANTY sanitary sight flows are designed with the same attention to safety as industrial units. They are available with Tri-Clamp®, butt weld, TS, or any available sanitary connection.

CANTY SANITARY JET SPRAY RINGS

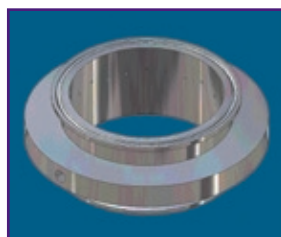

Tri-Clamp® Jet Spray Ring

To manufacture a FuseVIEW™ we heat the glass to it's molten point where it flows to the wall of the metal. At that point the glass fuses or bonds to the metal. Then we slowly cool the FuseVIEW™ until the glass solidifies. The metal has a higher coefficient of expansion than the glass and the metal compresses on the glass. This squeezing prestresses the glass and puts it under radial compression. Glass is strong in compression but not in tension or shear. When the FuseVIEW™ is pressurized the glass bends and relieves the compression and avoids tension. This is the same as is done in concrete - it is prestressed in compression in order to take bending.

THE CANTY ADVANTAGE



CANTY

Metal Glass

- | | |
|--|--|
| <ul style="list-style-type: none"> • Full 3.0" [76 mm] view (4" Tri-Clamp®) • Hastelloy® C, Hastelloy® C276 and Hastelloy® C-22® | <ul style="list-style-type: none"> • 2.17" view [55 mm] (4" Tri-Clamp®) • DIN 1.4462 = Duplex SS NOT 316L SS |
|--|--|

CANTY provides the largest view possible!



CANTY

Metal Glass

- | | |
|---|--|
| <ul style="list-style-type: none"> • CANTY model is hermetically fused. Note - glass is still fused to the ring after cutting. (Comparable models shown cut with band saw) | <ul style="list-style-type: none"> • Not actually fused! Metal section breaks away cleanly. |
|---|--|

HOW IT WORKS!



CANTY QUICKPORT™ Closures

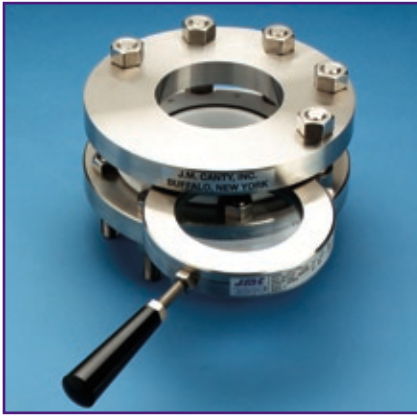

QUICKVIEWPORT™

The CANTY QUICKPORT™ is a patented, safe, quick opening closure for process vessels. Originally used in the offshore diving industry as a transfer lock on decompression chambers, QUICKPORTS™ are used with no additional interlock by the tank to be pressurized or evacuated. A pressure differential holds the door securely in place and no bolting is involved. Meets ASME code section VIII for quick opening closures. Optional positive interlocks for hazardous or lethal service are available.



QUICKFILLVIEWPORT™

The QUICKPORT™ features a hinged door or window that opens laterally to provide full port access. The closure consists of a pad and a retaining flange held apart by spacers, a floating seal ring and a door or sight glass. As the door is pivoted into the closure the spring loaded seal ring is deflected back to allow the door or sight glass to fit tightly between the flanges. The spring force creates an air tight seal on the door face and allows the tank to be pressurized or evacuated.

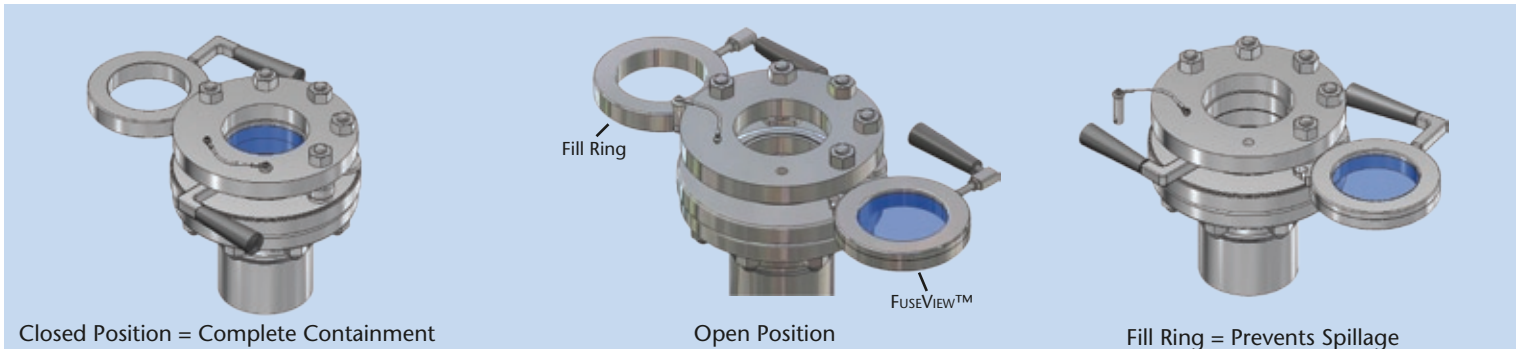

Closed Position = Complete Containment

Open Position

Fill Ring = Prevents Spillage

QUICKPORT™ APPLICATIONS

- Powder Charging
- Sampling
- Pilot Plant Vessels

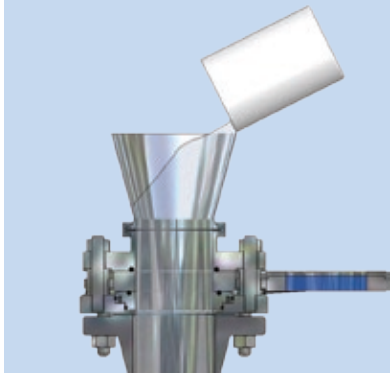

Funnel = Clamp-On or Drop In

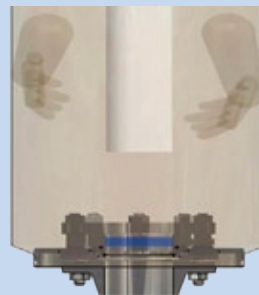

Glove Bag

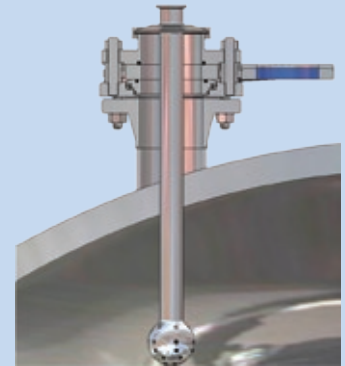

Sprayball = No Additional Nozzle Needed

QUICKPORT™ HAZOP OPTIONS

- Air Cylinder Locking Pin
- Spring Loaded Locking Pin
- Interlock Available For Hazardous Operations
 - Not Needed For Pressure Safety
- Limit Switch



Vessel Charging and Sampling with Dover Pac®

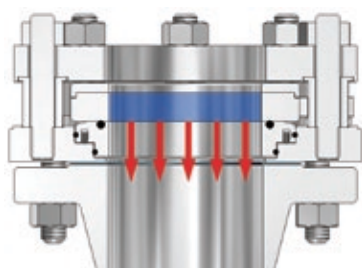

Seal Under Vacuum

HOW IT WORKS!

The zero leak design has been proven through a combination of air / liquid submergence testing. This cycles the QUICKPORT™ through external pressure, no pressure and ultra high internal pressure leak testing where a constant o-ring seal is maintained.

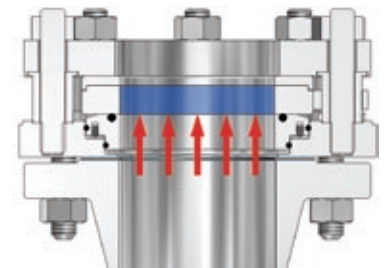

Seal Under Positive Pressure

CANTY Industrial Surveillance Cameras & Telemetry Systems

ETHERNET

- TCP/IP Communication
- Simultaneously View Multiple Cameras
- Low Installation Cost - Uses Ethernet Cabling
- Available in Rugged Industrial Enclosures
- Windows® Compatible
- Point and Click Control
- 1600 x 1200, 640 X 480, 320 x 240, 160 x 120 Image Sizes
- Optional Video Recording Software – Burn To CD, DVD
- Archive to PC Hard Drive

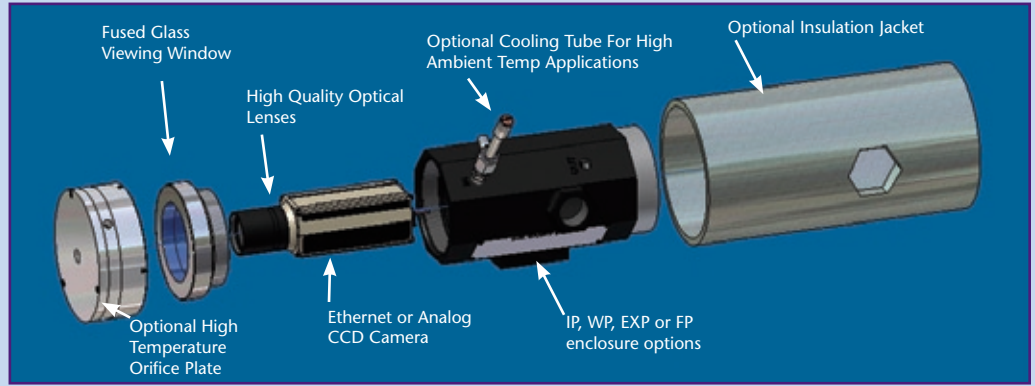

CONVEYOR FEED CONTROL



CHUTE PLUG CONTROL

After installing the CANTYVISIONCLIENT™ software on your Windows® based PC, users can simply point and click menu options to remotely view any CANTY camera from their PC desktop. CANTYVISIONCLIENT™ software is provided with a 5 client license per module which allows multiple users to simultaneously view and control CANTY pan & tilts and cameras. Site license upgrades are available.

Analog Output Models Also Available

Pan & Tilt With Surveillance Camera

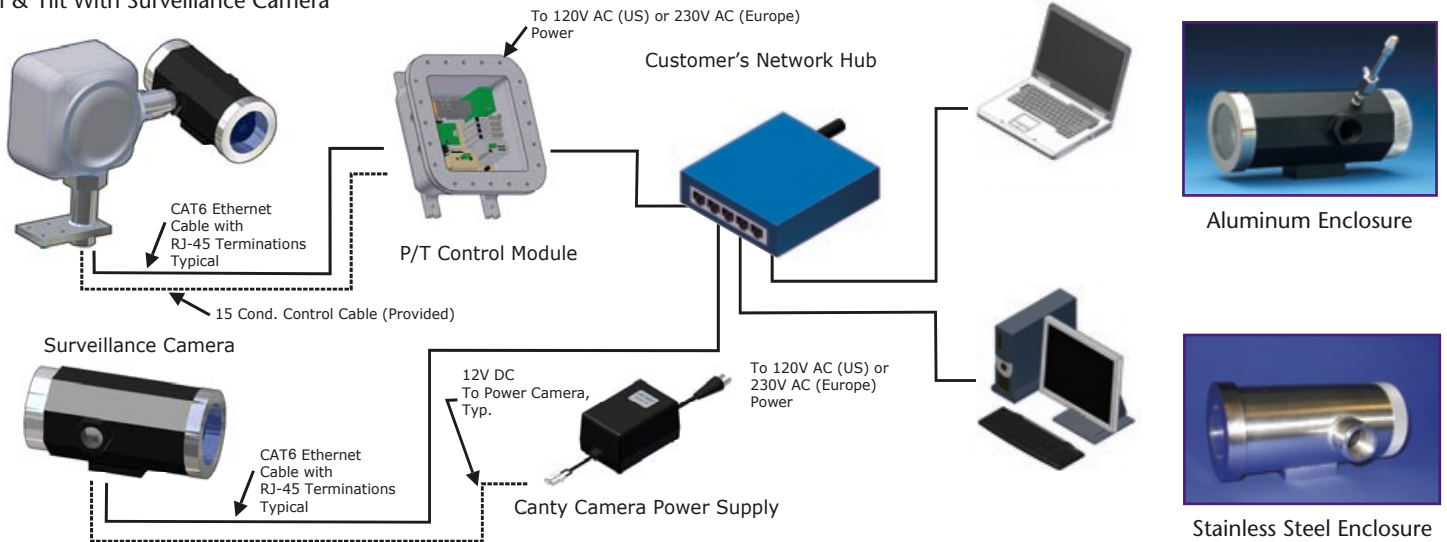

TYPICAL INDUSTRIAL ETHERNET SURVEILLANCE CAMERA APPLICATIONS

VISION BASED BELT VOLUME FLOW AND MEASUREMENT

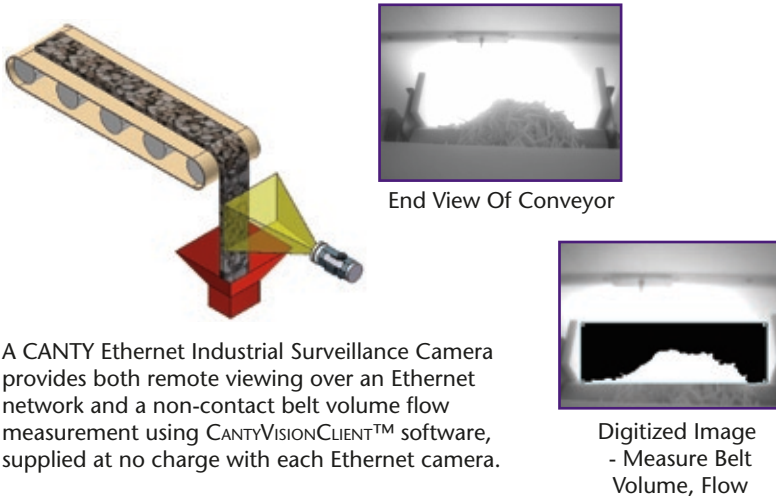

A CANTY Ethernet Industrial Surveillance Camera provides both remote viewing over an Ethernet network and a non-contact belt volume flow measurement using CANTYVISIONCLIENT™ software, supplied at no charge with each Ethernet camera.

HAZARDOUS VAPOR LEAK DETECTION

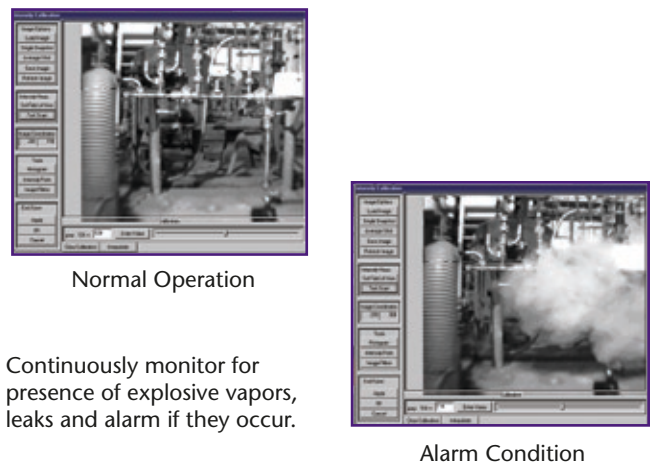

Continuously monitor for presence of explosive vapors, leaks and alarm if they occur.

CANTY High Temperature Cameras

CANTY High Temperature Cameras are ideal for demanding applications involving visual inspection or verification in extreme temperature environments. CANTY High Temperature Camera Systems feature a fused glass seal that is standard equipment with every model. This unique seal provides an impenetrable safety barrier to protect the camera electronics from the harsh process environment and prevents hazardous vapors from escaping into your plant.

ULTRATEMP™ INSERTION HIGH TEMPERATURE CAMERAS



- No cooling air required. Air is used for cleaning only
- 2000°F [1090°C] or 2500°F [1370°C] models
- High temperature furnace package
- 12"-36" insertion length models available to insert through refractory wall
- High quality quartz optics
- Disposable, protective quartz shield
- Auto electronic iris
- Non-blooming CCD camera - analog or Ethernet

EXTREMEEMP™ GLASS FURNACE CAMERAS

Designed for the extreme 3000°F [1650°C] max. temperature requirements of glass furnaces, the EXTREMEEMP™ Glass Furnace Camera combines a CANTY ULTRATEMP™ Camera with an Inconel sleeved high temperature refractory jacket. The assembly is inserted thru an opening in the fire brick, providing a remote view into the furnace.

- 3000°F [1650°C] max. rating - extreme temperature furnace lens
- High quality quartz optics
- Auto electronic iris
- Disposable quartz protective shield
- Non-blooming CCD or Ethernet cameras
- Cooling air required

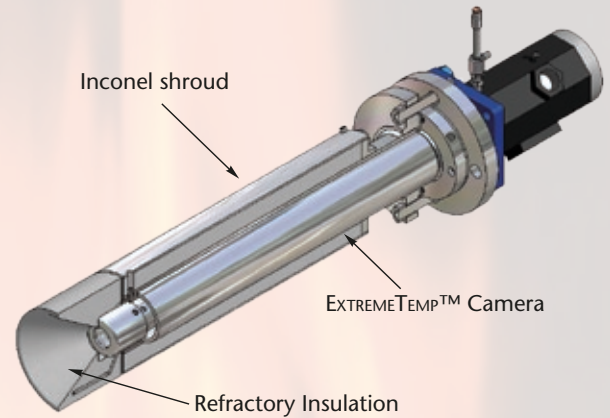

ULTRATEMP™ FLUSH MOUNT HIGH TEMPERATURE CAMERAS

- Ideal for applications where combined refractory and nozzle length are < 4" [102mm]
- 2000°F [1090°C] process temperature / 1300°F [700°C] at lens
- 3" 150# ANSI or 80 mm 16 bar DIN flange mounting options
- Includes protective quartz shield and spray ring assembly

HIGHTEMP™ SURVEILLANCE CAMERAS

- View and measure process attributes with high accuracy
- Remotely mounted - direct line of sight
- Ambient temperatures to 200°F [90°C]
- Ethernet connectivity
- Includes high temperature insulation and glare filters
- Optional mounting stands available



MINIEMP™ HIGH TEMPERATURE CAMERAS

MINIEMP™ cameras are low cost, low maintenance, portable alternatives to traditional high temperature cameras. Our unique design allows the unit to be easily moved from one location to the next in just minutes. They can be configured to fit any insertion length requirement.

MINIEMP™ cameras depend upon an uninterrupted air stream to maintain integrity. If air is lost, the internal CCD camera and lens may require replacement. However, the remaining components will remain fully functional.

CANTY THERMALVISION™ System Applications

CANTY provides continuous temperature measurement by using multiband wavelength imaging pyrometry. With the advancement of CCD technology, multiband measurement has several advantages over 2 color (2 wavelength) pyrometers:

- Product temperature measurement is integrated over a broader range of wavelengths, which minimizes variance in emissivity.
- VIS (Visible spectrum) between .4 - .7 micron allows a wide range of materials to be measured without recalibration or adjustment to emissivity.

With the use of VIS, NIR and IR wavelengths, the proper THERMALVISION™ Camera can be selected to provide the most accurate temperature measurement range available. CANTYVISIONCLIENT™ software provides a SMART temperature measurement in addition to molten level tracking, object position and temperature measurement specific to an object or process.

Calibration is performed to ASTM standard, providing for accuracy and repeatability of ±1°C

WASTE/ENERGY INCINERATION, THERMAL OXIDIZERS, KILNS: CEMENT, LIME, IRON ORE



Actual VIS THERMALVISION™ Camera measuring rod temperatures 750°F [400°C] - 2865°F [1575°C]

Spectrum	Temperature Range
VIS	750°F [400°C] to 3630°F [2000°C]
NIR	570°F [300°C] to 1830°F [1000°C]
IR	32°F [0°C] to 750°F [400°C]

* For Reference Only

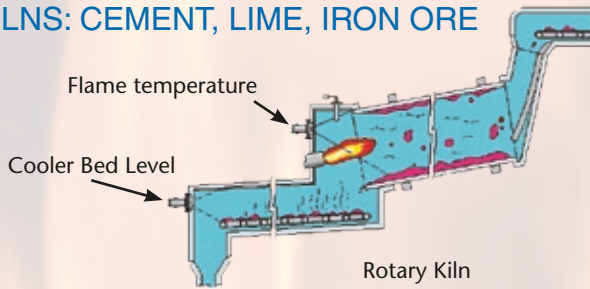

Rotary Kiln

Canty provides real time measurement of bed level to maintain a proper energy balance as well as temperature control.

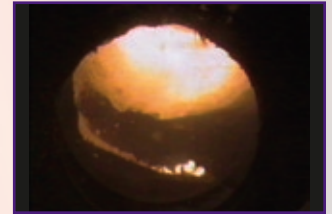

Rotary Kiln

An Ethernet THERMALVISION™ high temperature camera continuously monitors tube temperature. Various communication protocols as well as 4-20mA current loop outputs provide real time temperature measurement. Single point, multi point or multi area measurements are provided with one THERMALVISION™ camera.

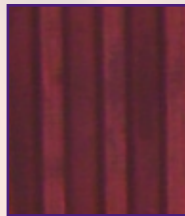

Tube Temperature

REFINERY

Monitor/verify flame presence and measure temperature with a CANTY THERMALVISION™ camera system.



Flame Monitoring

GLASS INDUSTRY

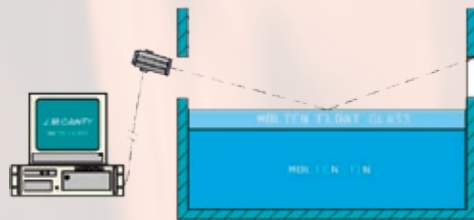

Track Glass Level From Reflected Image of Thermal Well

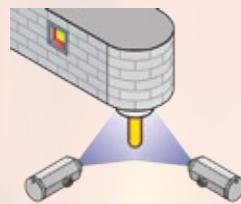

Glass Gob - Volume and Temperature



Glass Gob

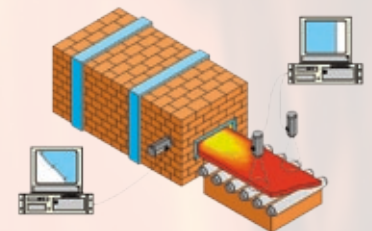

Float Glass Width

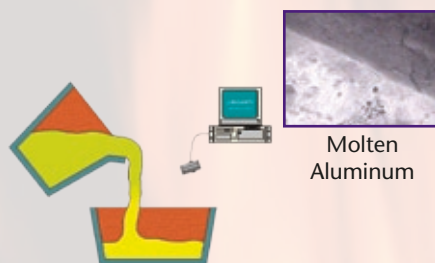

Molten Level, Temperature, Slag Detection



Molten Aluminum

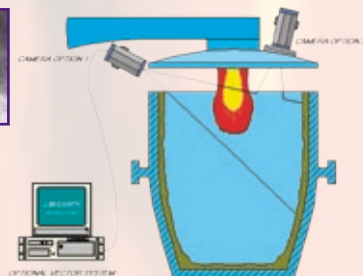

Mixed Gas Flame Safety Monitor



Slab Position

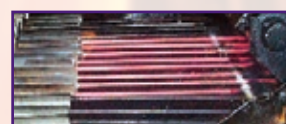

Wire Width and Temperature

MOLTEN METAL

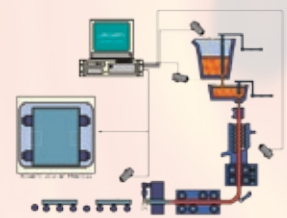

Continuous Caster

CANTY Camera & Light Vision Systems

PILOT PLANT PRODUCTION TANKS



Flange Mount



Flanged Mount w/ Insertion Optics



Sanitary Connection

CANTY Camera & Light Vision Systems are a patented design to view and illuminate the inside of a pressure or process vessel through a single connection. There is no need for multiple ports! CANTY can supply an integrally mounted camera and light (optional) in flanged, sanitary or NPT threaded process connections. Analog or Ethernet CCD cameras provide a real time view inside the tank under process conditions. CANTY fused glass technology provides a safe, high pressure, high temperature, hermetic fused glass barrier between the process and the camera electronics.

The key to CANTY Camera & Light Vision Systems is the CANTY Light. CANTY uses fiber optic light guides to focus cool, effective light into a process or pressure vessel. Cool light eliminates product bake-on, adding no heat to the process. Fiber optic light guides deliver the maximum amount of light into the tank. The resulting live, remote image from a CANTY Camera & Light Vision System is unparalleled!

- Worldwide approvals
- Various models rated to 10,000 PSI [690 bar], temperatures to 2000°F [1090°C].
- High resolution CCD cameras - Ethernet or analog output
- B&W or Color models
- Single nozzle viewing & illumination
- Ideal for pilot plants - view and record your process
- Remotely view process from the comforts of a control room
- Remote light dimming options
- Optional Jet Spray Rings available

LEVEL CONTROL



Level Control

- Non-contact level control
- Foam detection
- Verify empty
- Visual verification
- Conical Shaped Vessels
- Hemispherical Shaped Vessels



Solid Level

FOAM DETECTION



- NON-CONTACT Foam control
- Plastic & Resins
- Percent Foam
- Verify empty
- Conical Shaped Vessels
- Hemispherical Shaped Vessels

SPRAY DRYER

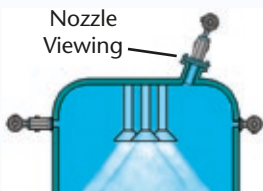

Nozzle Viewing

- Monitor Spray Patterns
- Detect Plugs
- Visual Verification
- Avoid a Fire

Black Speck detection can monitor for defects at the bottom of the spray dryer.

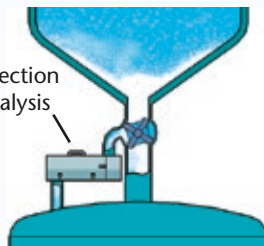

Black Speck Detection Particle Size Analysis

NUTSCHE FILTER



Real Time Level Measurement and Cake Detection

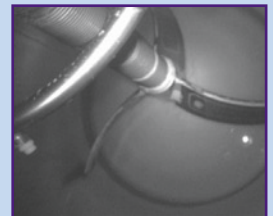

- Cake Detection
- Non-Contact Level Control
- Visual Verification
- Stop Washing Product Away
- Avoid Cracking Cake Layer

CENTRIFUGE LEVEL



- Thickness Control
- Level Control
- Verify Empty
- Visual Verification
- Color Detection

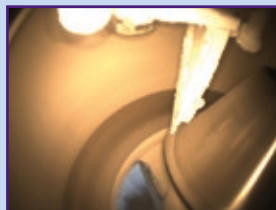

Centrifuge

INTERFACE DETECTION

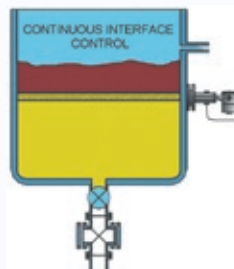

- Phase Split
- Control Rag Layer
- No False Readings
- Visual Verification
- Never Mix or Miss Phases

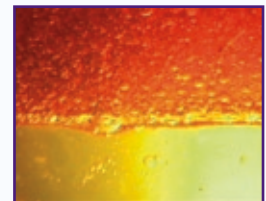

CANTY PARTICLE SIZING

Fermentation

Canty dynamic image processing performs several valuable functions in fermentation. The system captures images for cells down to .7 microns (.3 micron with phase contrast) and identifies the cell size distribution and culture count for process control. In many cells the cell viability is determined since a count of the ratio of live to dead cells is calculated by way of the cell structure that the image calculates

Perfusion

- Cell Culture Information

CIP

- Monitor for TOC and Particle Level
- Reduce Lab Time

Chromatography

- Bead Size Verification
- Free From Bubbles

Batch Fermentation

- Measures Cell Size / Distribution / Count
- Visual Verification

WFI

- Continual Monitoring of Particulate Level
- Longer Campaigns

Ultrafiltration & Centrifuge

- Whole/Rupture Cell Breakthrough detection
- Free from bubbles

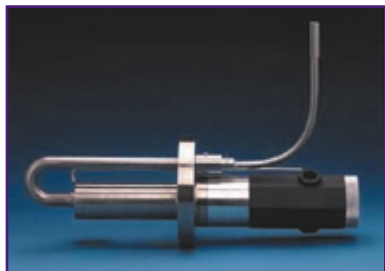
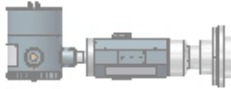

SUGARSCOPE™ Reactor Side Mounted

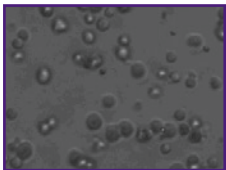

Mammalian Cells

CRYSTALSIZER™ Glass Reactor



Crystallization

Control of Crystallization is one of the most important factors effecting product yield and quality. Image based particle size and concentration uses high speed imaging sensors with a resolution down to .7 micron to capture the particulate in real-time. Analysis can be accomplished in pipeline or in a crystallization reactor.



CRYSTALSCOPE™ Reactor Top Mounted

CANTYCRYSTALSCOPE™ Advantages

- Real-time crystal size analysis
- Crystal distribution by major, minor diameter, area, perimeter, aspect ratio, circularity.
- Crystal size & shape
- Crystal count
- Density of crystals
- Detection of seeding problems
- Automated temperature & vacuum controls during crystal growth
- Increased efficiency during filtration

Dynamic imaging processing is the only method of providing cell and crystal sizing, shape, color and viability in the lab and online in the process. There are several areas in fermentation and Bio-processing where online and PAT applications have been successfully implemented.

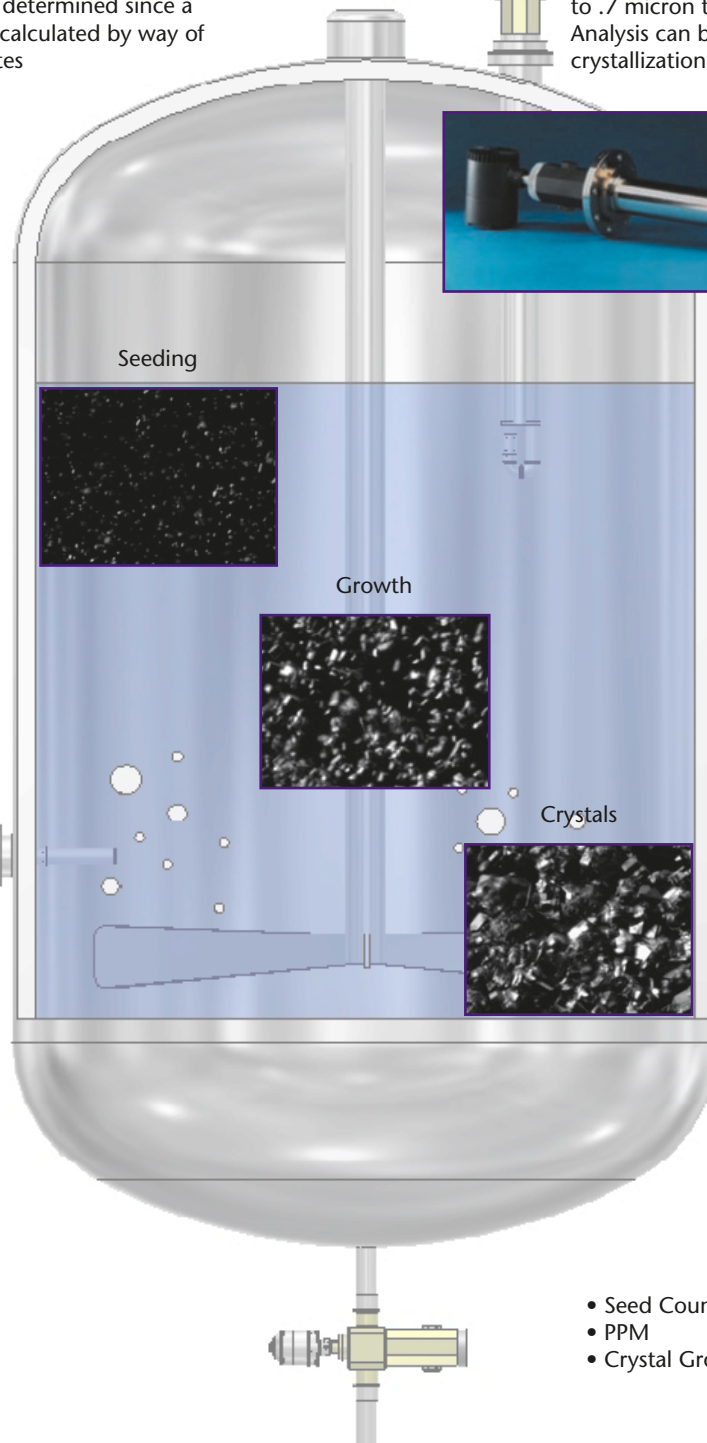

- Seed Count
- PPM
- Crystal Growth

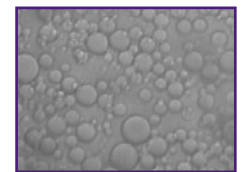

Chromatography Beads

Lab

The CANTY Lab CRYSTALSIZER™ is a process vessel with an integral particle analyzer. Sizes range from 1 liter to 500 liter. The analyzer uses the patented CANTY process microscope along with proven unique processing software to provide a complete analysis of size, shape and distribution. Seeding and seed agglomeration problems are easily detected. In addition, the polymorphs of the different crystals can be detected and measured.

CRYSTALSIZER™ Lab Reactor

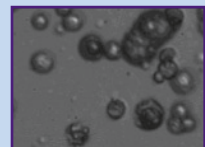

CANTY

Liquid Analysis

Particle Size - Slurries - Suspensions

MICROFLOW™



- Variable magnification lens for analysis of different size samples
- A high output light source with uniform light field to display silhouette images of opaque particles and translucent particles.

CANTY offers many systems for laboratory particle sizing analysis that have been engineered to provide the user a means by which a liquid is analyzed while under varying pressures, temperatures and flow rates. The MICROFLOW™, MACROFLOW™ and the LABCRYSTALSIZER™ offer sample or continuous, microscopic, non-destructive viewing. They provide particle size analysis on 1 micron and larger samples with two dimensional results when used in conjunction with CANTYVISIONCLIENT™ software

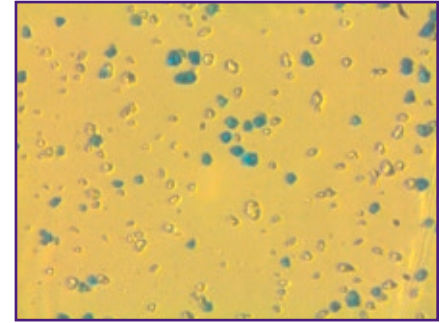

Ink Toner Image from MICROFLOW™

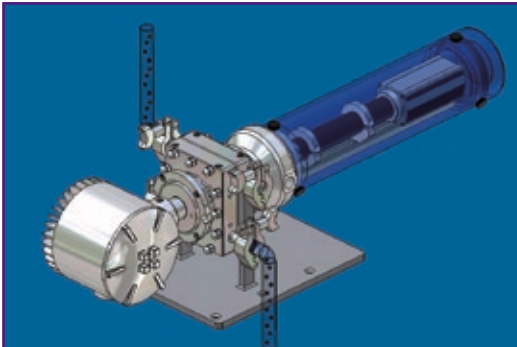

- Variable flow gap spacing to obtain optimal image for particle sizing
- Ability to view real-time data and images
- Store and recall images for further analysis

MICROFLOW™ with Pressure Pots



- FUSEVIEW™ window is the product contact barrier
- Rated 150 PSI [10 bar] @ 500°F [260°C], Options through 6,000 PSI [400 bar]
- On-Line or LABPLUS™ (remote control)

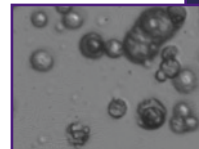
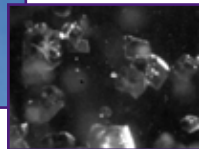

MACROFLOW™



IMMERSION TURBIDITY ANALYZER

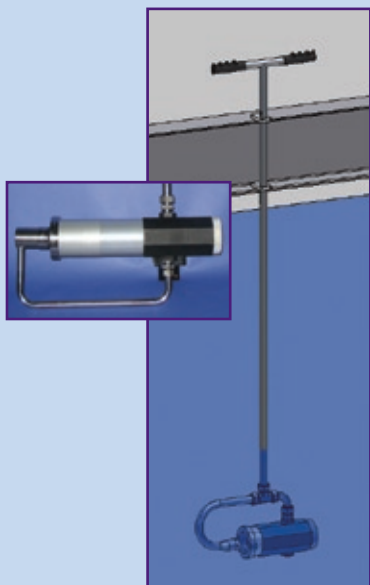

System Capability:

- Particle Size
- Turbidity
- Percent Solids

Applications:

- Hydrosizers
- Transfer Boxes
- Floatation Tanks

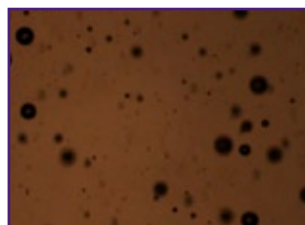

CANTY INFLOW™ PARTICLE SIZING

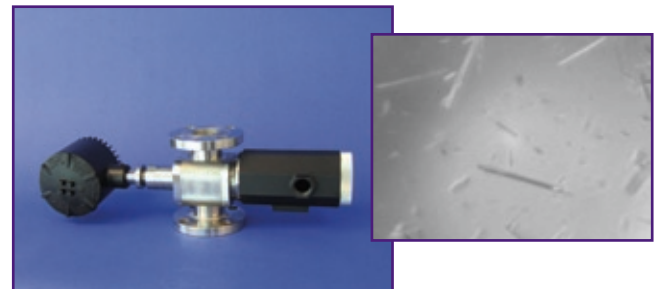

Concentration Measurement

Concentration down to the PPM/PPB level is accomplished by digitally analyzing the size and shape of the droplets or particles to calculate the volume.

Oil & Gas Analysis

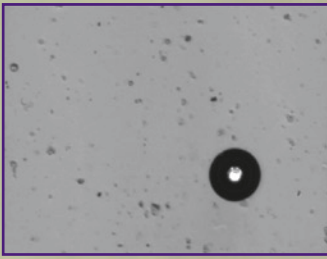

• WATER in OIL

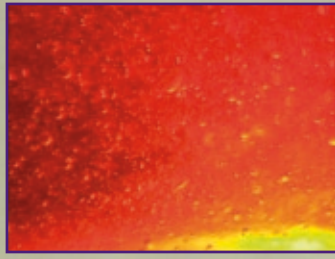

• OIL in WATER



• WATER in OIL/BSW



• ASPHALTENES

• PPM/PPB

• PARTICLE DISTRIBUTION

• SOLIDS

• HYDRATES

• FAME

FUEL analysis of color, **SOLID/PARTICULATE**, and **WATER** is a critical measurement in several areas ranging from the refinery **JET FUEL** to pipeline and product coloring. CANTY fuel analysis provides detection of solids, water, and **FAME**(bio-particulate) as well as color and haze.

REFINING DESALTER Oil in Water analysis is measured to the **PPM** level with the addition of droplet size. **WATER in OIL** (BSW) analysis in a pipeline of crude and detection of water slug helps in process control and custody transfer. **COLOR** analysis of **JET FUEL** along with particle and water is a critical quality measurement during distillation and transfer. **OIL in WATER** in the steam condensate hurts energy efficiency. **OIL in WATER** in waste treatment helps meet the EPA guidelines.

EXPLOSION PROOF / FLAMEPROOF at-line and in-line systems are the best solution for process control. The high resolution Canty optics, down to .7 microns, allow MFT (manufactured fine tailings) to be analyzed, distinguishing the solid particles from the liquid droplets.

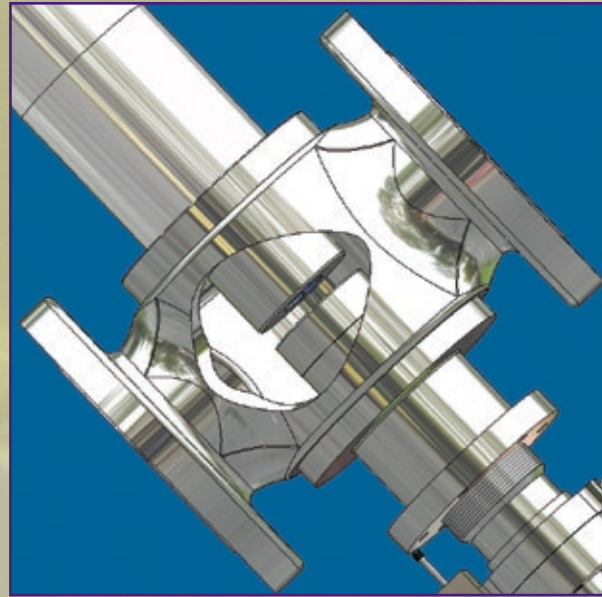

LUBE OIL measurement of soot, solids and water provides valuable information on the health of heavy mechanical equipment allowing for detection of changes which would quickly indicate a problem.

PRODUCED WATER measurement of **OIL**, **SAND**, and **GAS BUBBLES** provides the multiphase analysis that is needed to reliably control the separation and minimize chemical use. In-line imaging is the ideal way to measure oil in water since UV and IR measurement can be erroneous due to the chemical addition.

TAR SANDS and heavy crude are ideal applications to measure water and solids due to the demanding pressures and temperatures of the slurry. **BS&W** measurement in crude oil is critical for custody transfer and process control. Canty provides PPM concentration of each component as well as particle distribution. Hydrates and **WAX** are detected and sized in the system to help control them.



INFLOW



IN-LINE ANALYZER



AT-LINE ANALYZER



LAB/PORTABLE ANALYZER

CANTY ADVANTAGE

- Detects Oil/Water/Sand/GAS
- .7 micron - 4.8 mm particle size options
- High throughput
- At pressure and Temperature Analysis
- Visual Verification
- FM, ATEX and Weatherproof approved models

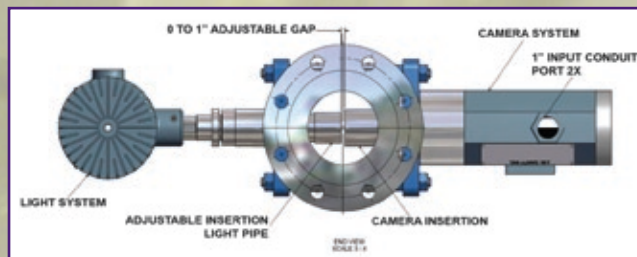

UNRESTRICTED FLOW CONSTANT CROSS-SECTIONAL AREA

- Particle Size/Shape/Color
- Bubbles do not effect output
- No Buildup
- Continuous Real Time View
- Visual Verification
- Provides both a real-time, in-line measurement and a continuous real-time view of the product

Particle Analysis - Size, Shape, Color

Solid Particles – Laboratory Analysis

CANTY PARTICLE SIZING AND SPECK DETECTION

Laboratory SOLIDSIZERS™

CANTY Laboratory SOLIDSIZERS™ are vision-based analyzers for dry particle size measurement and speck detection in a laboratory environment. The SOLIDSIZER™ includes a camera with shutter speed control, a variable magnification lens, a high output light source with a uniform light field to display silhouette images of opaque particles and an enclosed vibratory feeder to present sample material to the camera / light in free fall. The sample images are digitally analyzed to obtain particle characteristics.



LABPLUS SOLIDSIZER™ with Automated Ethernet Control
10 micron - 50 mm Options

- Completely Automated Package
- Ethernet Communications
- Software Control of All Functions
- Enclosed Feed Tray

The LABPLUS SOLIDSIZER™ is a fully automated particle characteristic analyzer and is ideal for any laboratory application.

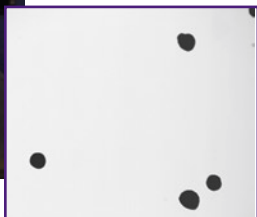

Applications

- On-line particle sizing
- Powders/granules
- Rocks/pellets
- Black speck detection
- Crystallization growth
- Shape analysis

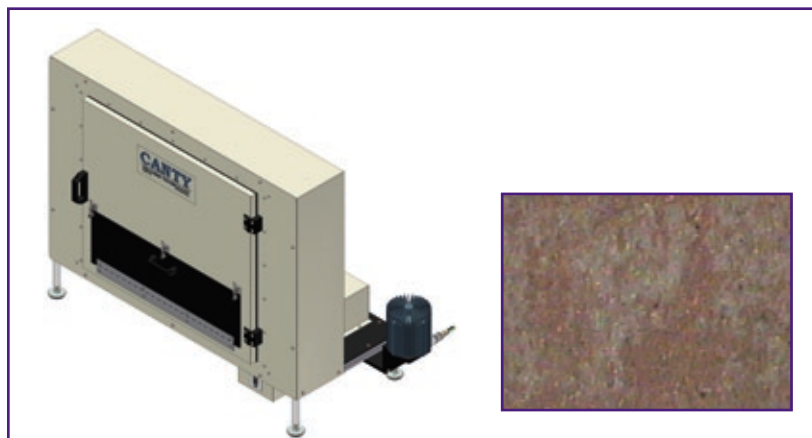

LAB COLORIMETER
Saybolt, (R,G,B), CIE Options

- Save Images
- Visual Verification
- No Constant Recalibrating
- Canty White Light

An excellent laboratory color analyzer, the Lab Colorimeter provides manual control of all parameters required to accurately and repeatedly measure color characteristics.

Industries

- Plastics
- Fertilizers/detergents
- Mining/crushing
- Food
- Glass
- Biotech
- Pharmaceutical

PARTICLE, COLOR ANALYSIS AND SPECK DETECTION

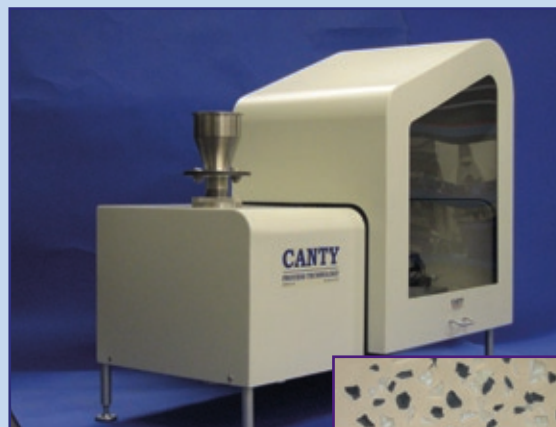

SOLIDSIZER™ TS
10 micron - 50 mm Options



- Completely Automated Package
- Ethernet Communications
- Software Control of All Functions
- Includes additional vision module for color analysis, speck detection.

The SOLIDSIZER™ TS is a fully automated, particle characteristic and color analyzer. All functions are computer controlled, with an easy to use, comprehensive analysis and control software package. The SOLIDSIZER™ TS is ideal for any laboratory application.

LAB SOLIDSIZER™ With Color Analysis



The LAB SOLIDSIZER™ With Color Analysis builds upon the LAB SOLIDSIZER™ framework. By integrating an additional color vision system module, Canty provides continuous color analysis and speck detection as well as particle characterization of the sample.

CANTY

Particle Analysis - Size, Shape, Color

Solid Particles – On-line

CANTY ON-LINE PARTICLE SIZING ANALYSIS

The CANTY SOLIDSIZER™ is a robust particle sizing unit used for sizing particles as small as 10 microns, with models available for particles as large as 22 cm. With any CANTY system, particle size analysis occurs in real-time with two dimensional imaging to determine the products size, shape, and color. Images and video of the product can be stored for retrieval and analysis by CANTYVISIONCLIENT™ software, producing an ideal particle sizing system that can benefit a multitude of industries.



INDUSTRIAL SOLIDSIZER™

- 10 microns - 50 mm Options
- WP, IP, Explosion Proof or Flame proof Environments

SOLIDSIZER™ Applications

- Food - Coffee, Cereals, Candies
- Detergents
- Pharmaceutical - Powders, Capsules
- Mining - Aggregates, Crusher Control
- Iron Ore Pellets
- Wood chips
- Plastics
- Agricultural Products
- Many, Many More!

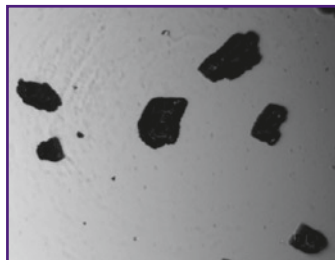
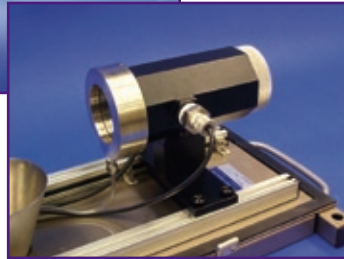
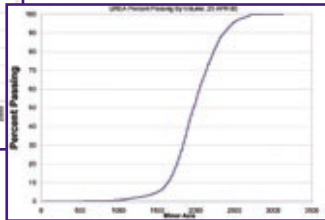
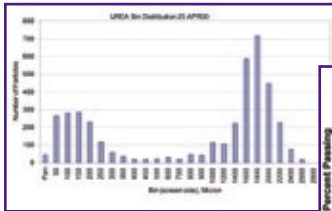

Raw image of stone in RockSizer™



CANTYVISIONCLIENT™ Software Measuring Product



3-D RockSizer™

- 2.5 mm - 230 mm Options
- For Aggregate Applications
- WP, IP, Explosion Proof or Flame Proof Environments

The RockSizer™ Advantages:

- Designed to withstand the harsh environments typical of the mining industry
- Rugged, skid mount style frame
- 3D particle size and shape analysis
- Real-time, On-line particle size analysis
- Dual uniform backlighting for true shape illumination
- Easy, rapid system configuration

FOOD On-Line & Lab

System Capability

- Particle Size
- Color and Size
- Volume Flow
- Automate Your Process
- Visual Verification



Applications

- Coffee
- Sugar
- Potato Chips
- Candy
- Chocolate
- Powders

BEVERAGE On-Line & Lab

System Capability

- Dissolution Particle Size/Time
- Color and Shape
- Turbidity and Percent Solids
- Oil in Water
- Water in Oil
- FOG Monitor
- Independent of Bubbles
- Automate Your Process
- Visual Verification

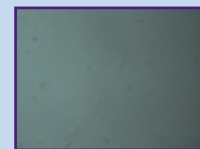

Applications

- Coffee
- Liquid Sugar
- Oil Cooking
- Gels or Pastes
- Creams
- Energy Drinks
- Beer/Spirits/Wine
- Milk

CANTY'S GOAL IS TO PROVIDE EQUIPMENT TO ENHANCE PROCESS CONTROL AND YIELD. WE ACCOMPLISH THIS BY DESIGNING, MANUFACTURING AND SERVICING THE FINEST EQUIPMENT IN THE WORLD.

Some Of Our Valued Customers

3M
ABBOTT LABS
ABEC
ADM
AGC
ALCOA
AMGEN
AMGEN
BASF
BAYER
BIOGEN IDEC
BRISTOL-MYERS SQUIBB
CARGILL
CHEVRON PHILLIPS
CLIFFS MINING
CONOCO PHILLIPS
CRB
DEAD SEA WORKS

DOW
DUPONT
EASTMAN CHEMICAL
ELI LILLY
EXXONMOBIL
FIRESTONE
FREEPORT MCMORAN
FLUOR
GLAXOSMITHKLINE
GOODYEAR
HONEYWELL
HUNTSMAN
INTERNATIONAL PAPER
JACOBS ENGINEERING
JOHNSON&JOHNSON
KRAFT
LAFARGE

LONZA
MERCCK
NATIONAL STARCH
NESTLE
NIRO
NOVARTIS
NUCOR STEEL
OWENS ILLINOIS
PFIZER
PPG
PROCTER & GAMBLE
ROCHE
SAUDI KAYAN
SANOFI-AVENTIS
SYNCRUDE
US STEEL

Industries

ABRASIVES
AEROSPACE
AGRICULTURE
BIOFUELS AND SYNFUELS
BIOTECHNOLOGY
CEMENT
CERAMICS
CHEMICAL
FOOD, BEVERAGE AND BREWERY
GLASS
MINING
OIL, GAS AND COAL
PETROLEUM AND PETROCHEMICAL
PHARMACEUTICAL
PULP AND PAPER
STEEL AND METALS
STONES AND AGGREGATE
WATER AND WASTE

AND YOU!!!



J.M. Canty Inc.
6100 Donner Road
Buffalo, NY 14094
Phone: (716) 625-4227
Fax: (716) 625-4228

Email: sales@jmcanty.com



J.M. Canty International Ltd.
Ballycoolin Business Park
Blanchardstown
Dublin 15, Ireland
Phone +353 (01) 882-9621
Fax: +353 (01) 882-9622

Email: sales.ie@jmcanty.com

WWW.JMCANTY.COM